

# Accessories for MCCBs Ex9M



- Accessories for Ex9M line devices
- Auxiliary contacts synchronous with main contacts
- Signal contacts active on electrical tripping of the circuit breaker (tripping signal contacts)
- Shunt trip and undervoltage releases
- Remote operators
- Rotary handles
- Connection terminals and covers
- Mounting depth spacers and adaptors

Accessories suitable for Moulded Case Circuit Breakers Ex9M. It is possible to supplement or modify functions of a basic circuit breaker by installing of suitable accessories.

Circuit breakers can be equipped with auxiliary contacts AX21 (up to 2 units even for M1 frame size) and one unit of signal contact AL21 or early make auxiliary contact EC 2*i*. AX21 and AL21/EC 2*i* are mounted into different positions, a use of one type of the contact does not limit a number of the second type. AX21 and AL21/EC 2*i* can be used regardless the frame size of the circuit breaker.

One unit of undervoltage release UVT2*i* or one unit of shunt trip relase SHT2*i* can be installed in the breaker. Different versions for different frame sizes allow to optimise power consumption of these units.

The circuit breakers can also be equipped with different accesories for operation of the toggle. There are available direct rotary handle, rotary handle with extended shaft e.g. for door coupling and a motor operator.

Mounting of the device onto plate can be done directly with the screws which are included in the scope of delivery. Or in case of M1 and M2 devices there is possibility to use adaptors DRA for mounting onto DIN-rail 35 mm. If it is requested to place devices of different frame size side by side, it is possible to use for compensation of differences in height mounting depth spacers WG which assure the same position of front panel towards front plate.

For connection of conductors there are available various types of box and tunnel terminals MC.

# Accessories for MCCBs Ex9M

## Auxiliary and signal contact units

- Contact units for auxiliary and signal contact functions are suitable for all frame sizes
- Auxiliary contacts synchronous with main contacts of the circuit breaker
- Signal contacts active on electrical tripping of the circuit breaker (tripping signal contacts)
- It is possible to use 1 unit AL21 plus up to four units of AX21 in one MCCBs (depends on frame size)



Function	Frame size	Contacts	Article No.	Type	Packing
Auxiliary	all	1 CO	101395	AX21	1/24
Signal	all	1 CO	101396	AL21	1/24

## Early-make auxiliary contacts

- Used mainly for interlocking, load shedding or emergency off application circuits
- Does not limit using of voltage releases and motor operator
- It is possible to use 1 unit EC 2i in one MCCBs
- Compatible with MCCB devices produced from 3/2014 only!  
Please, note the requirement for early-make contact function in the order of MCCB!



Function	Frame size	Contacts	Article No.	Type	Packing
Early-make aux.	M1, M2	1 NO	106315	EC 21	1
Early-make aux.	M3, M4, M5	1 NO	106317	EC 23	1

## Shunt trip releases

- It is possible to use one unit of shunt trip release SHT2i or one unit of undervoltage release UVT2i



Aux. cont.	Frame size	Operating Voltage	Article No.	Type	Packing
-	M1	48V AC	101397	SHT21 AC48V	1/24
-	M1	110V AC	101398	SHT21 AC110V	1/24
-	M1	220-240V AC	101399	SHT21 AC220-240V	1/24
-	M1	380-415V AC	101400	SHT21 AC380-415V	1/24
-	M1	24V DC	101401	SHT21 DC24V	1/24
-	M1	48V DC	101402	SHT21 DC48V	1/24
-	M1	110-120V DC	101403	SHT21 DC110V	1/24
-	M1	220V DC	101405	SHT21 DC220V	1/24
-	M2, M3	48V AC	101416	SHT22 AC48V	1/24
-	M2, M3	110V AC	101417	SHT22 AC110V	1/24
-	M2, M3	220-240V AC	101418	SHT22 AC220-240V	1/24
-	M2, M3	380-415V AC	101419	SHT22 AC380-415V	1/24
-	M2, M3	24V DC	101420	SHT22 DC24V	1/24
-	M2, M3	48V DC	101421	SHT22 DC48V	1/24
-	M2, M3	110-120V DC	101422	SHT22 DC110V	1/24
-	M2, M3	220V DC	101424	SHT22 DC220V	1/24
-	M4, M5	110V AC	103723	SHT24 AC110V	1/12
-	M4, M5	220-240V AC	103724	SHT24 AC220-240V	1/12
-	M4, M5	380-415V AC	103725	SHT24 AC380-415V	1/12
-	M4, M5	24V DC	103729	SHT24 DC24V	1/12
-	M4, M5	48V DC	103730	SHT24 DC48V	1/12
-	M4, M5	110-120V DC	103727	SHT24 DC110V	1/12
-	M4, M5	220V DC	103728	SHT24 DC220V	1/12

# Accessories for MCCBs Ex9M

## Undervoltage releases

- It is possible to use one unit of undervoltage release UVT2*i* or one unit of shunt trip release SHT2*i*



Aux. cont.	Frame size	Operating Voltage	Article No.	Type	Packing
-	M1	220-240V AC	101406	UVT21 220-240V AC	1/24
-	M1	380-415V AC	101407	UVT21 380-415V AC	1/24
-	M2, M3	220-240V AC	101425	UVT22 220-240V AC	1/24
-	M2, M3	380-415V AC	101426	UVT22 380-415V AC	1/24
-	M4, M5	110V AC	103733	UVT24 AC110V	1/12
-	M4, M5	220-240V AC	103734	UVT24 AC220-240V	1/12
-	M4, M5	380-415V AC	103735	UVT24 AC380-415V	1/12
-	M4, M5	110-120V DC	103736	UVT24 DC110-120V	1/12
-	M4, M5	220V DC	103737	UVT24 DC220V	1/12
-	M4, M5	24V DC	103738	UVT24 DC24V	1/12
-	M4, M5	48V DC	103739	UVT24 DC48V	1/12

## Remote operators

- Motor drives for electrical and remote control of MCCBs
- Available for all frame sizes



Frame size	Operating Voltage	Article No.	Type	Packing
M1	230 V AC	101411	MOD21 AC230V	1/8
M1	110 V AC	101412	MOD21 AC110V	1/8
M1	220 V DC	101413	MOD21 DC220V	1/8
M1	110 V DC	101414	MOD21 DC110V	1/8
M1	24 V DC	101415	MOD21 DC24V	1/8
M2	230 V AC	101430	MOD22 AC230V	1/8
M2	110 V AC	101431	MOD22 AC110V	1/8
M2	220 V DC	101432	MOD22 DC220V	1/8
M2	110 V DC	101433	MOD22 DC110V	1/8
M2	24 V DC	101434	MOD22 DC24V	1/8
M3	230 V AC	101484	MOD23 AC230V	1/4
M3	110 V AC	101485	MOD23 AC110V	1/4
M3	220 V DC	101486	MOD23 DC220V	1/4
M3	110 V DC	101487	MOD23 DC110V	1/4
M3	24 V DC	101488	MOD23 DC24V	1/4
M4, M5	230 V AC	103743	MOD24 AC230V	1/2
M4, M5	110 V AC	103744	MOD24 AC110V	1/2
M4, M5	220 V DC	103745	MOD24 DC220V	1/2
M4, M5	110 V DC	103746	MOD24 DC110V	1/2
M4, M5	24 V DC	103747	MOD24 DC24V	1/2

# Accessories for MCCBs Ex9M

## Direct rotary handles

- Rotary handle for direct mounting onto breaker
- Scope of delivery: mechanism block, rotary handle
- Indication of connected breaker status ON-OFF-TRIP
- Degree of protection IP40, IK07
- Can be locked in ON and OFF position with up to three padlocks (not in a scope of delivery)



Frame size	Colour	Article No.	Type	Packing
M1	Grey	101410	RHD21	1/36
M2	Grey	101429	RHD22	1/18
M3	Grey	101483	RHD23	1/9
M4, M5	Grey	103742	RHD24	1/6

## Extended rotary handles

- Rotary handle with extension shaft (extension shaft can be shortened)
- Possibility of longer extension shaft 500 mm (only the shaft as separated item)
- Scope of delivery: mechanism block, extension shaft, rotary handle
- Indication of connected breaker status ON-OFF-TRIP
- Degree of protection IP54, IK08
- Can be locked in ON and OFF position with up to three padlocks (not in a scope of delivery)



Frame size	Length	Colour	Article No.	Type	Packing
M1	300 mm	Grey	101409	ERH21	1/6
M2	300 mm	Grey	101428	ERH22	1/6
M3	300 mm	Grey	101482	ERH23	1/6
M4, M5	300 mm	Grey	103741	ERH24	1/4
All (only the shaft)	500 mm	-	110189	ERH2x ES 500mm	1/50

## Phase barriers

- Phase barriers to avoid short circuit due to ionised gas during tripping off of the breaker when unisolated busbars are used for its connection
- In the scope of delivery of MCCBs, separately orderable as a spare part
- Set consists of appropriate number of barriers suitable for both sides MCCB



Frame size	Poles	Article No.	Type	Packing
M1	3P	101441	PB21 3P	1 set
M2	3P	101444	PB22 3P	1 set
M3	3P	101491	PB23 3P	1 set
M4, M5	3P	103751	PB24 3P	1 set
M1	4P	104852	PB21 4P	1 set
M2	4P	104853	PB22 4P	1 set
M3	4P	104854	PB23 4P	1 set
M4, M5	4P	104856	PB24 4P	1 set

# Accessories for MCCBs Ex9M

## Connection terminals

- Connection terminals for MCCBs of all frame sizes
- Box and tunnel terminal versions
- For connecting with Al or Cu wires (box terminals only for Cu wires)
- Packed separately (for 3P connection, it is necessary to order 3pcs of terminal)
- Box terminals newly in the scope of delivery of AC devices M1, M2

### Box terminals



Frame size	Version	Terminals	Max. terminal capacity	Article No.	Type	Packing
M1	box	1	4-95 mm <sup>2</sup>	103705	MC21	1 pc
M2	box	1	10-120 mm <sup>2</sup>	103709	MC22	1 pc
M3	box	1	120-240 mm <sup>2</sup>	103715	MC23	1 pc
M3	box	1	120-240 mm <sup>2</sup>	103717	MC23 UL	1 pc

### Tunnel terminals



Frame size	Version	Terminals	Max. terminal capacity	Article No.	Type	Packing
M1	tunnel	1	16-95 mm <sup>2</sup>	103707	MC21 W	1 pc
M2	tunnel	1	35-240 mm <sup>2</sup>	103869	MC22 W	1 pc
M2	tunnel	2	35-120 mm <sup>2</sup>	103711	MC22 W2	1 pc
M2	tunnel	6	10-35 mm <sup>2</sup>	103713	MC22 W6	1 pc
M3	tunnel	2	120-240 mm <sup>2</sup>	103719	MC23 W2	1 pc
M3	tunnel	2	120-240 mm <sup>2</sup>	103871	MC23 W2 UL	1 pc
M3	tunnel	4	35-95 mm <sup>2</sup>	103721	MC23 W4	1 pc
M4, M5	tunnel	2	120-240 mm <sup>2</sup>	106314	MC24 W2	1 pc

### Screw terminals



Frame size	Version	Terminals	Screw size	Article No.	Type	Packing
M1	screw	1	M6	107873	MCS21	1 pc
M2	screw	1	M8	107874	MCS22	1 pc

## Terminal covers, short

- Terminal covers to increase touch protection of terminals



Frame size	Poles	Article No.	Type	Packing
M1	3P	101439	TCV21 3P	1 pc
M2	3P	101442	TCV22 3P	1 pc
M3	3P	101489	TCV23 3P	1 pc
M4, M5	3P	103748	TCV24 3P	1 pc
M1	4P	102372	TCV21 4P	1 pc
M2	4P	102374	TCV22 4P	1 pc
M3	4P	102376	TCV23 4P	1 pc
M4, M5	4P	103750	TCV24 4P	1 pc

# Accessories for MCCBs Ex9M

## Terminal covers, long

- Terminal covers to increase touch protection of terminals



Frame size	Poles	Article No.	Type	Packing
M1	3P	101440	TCE21 3P	1 pc
M2	3P	101443	TCE22 3P	1 pc
M3	3P	101490	TCE23 3P	1 pc
M4, M5	3P	103749	TCE24 3P	1 pc
M1	4P	102373	TCE21 4P	1 pc
M2	4P	102375	TCE22 4P	1 pc
M3	4P	102377	TCE23 4P	1 pc
M4, M5	4P	104855	TCE24 4P	1 pc

## DIN-rail adaptors

- Adaptors for mounting of MCCBs onto DIN-rail 35 mm
- Suitable for all variants of MCCBs and MCCB Switch Disconnectors of given frame size



Frame size	Poles	Article No.	Type	Packing
M1	3P, 4P	106319	DRA21	1
M2	3P, 4P	106320	DRA22	1

## Mounting depth spacers

- Set of mounting depth spacers for compensation of differences in height between frame sizes
- Assures the same position of front panel towards front plate
- Two variants with height 10 and 13 mm
- For compensation of heights please use these configuration:
  - M1 -> M2 = 1x WG10
  - M1 -> M3 = 1x WG10 + 2x WG13
  - M1 -> M4, M5 = 1x WG10 + 3x WG13
  - M2 -> M3 = 2x WG13
  - M2 -> M4, M5 = 3x WG13
  - M3 -> M4, M5 = 1x WG13



Frame size	Height	Article No.	Type	Packing
M1	10 mm	106321	WG 10	1 set
M2, M3, M4, M5	13 mm	106362	WG 13	1 set

## Mounting sets for MF line of sheet steel enclosures

- There are available tailored mounting panels and front plates for MCCBs and Disconnectors of size M1 and M2 as accessories of metal enclosures of line MF.
- Mounting plates are drilled with threads for easy mounting of MCCBs
- Front plates with particular device cut out for M1 and M2 devices (3P and 4P, vertical or horizontal position)
- For more details, please see catalogue "CONSUMER UNITS"

# Technical Data Ex9M Accessories

## Accessories for Moulded Case Circuit Breakers Ex9M

### Auxiliary and signal contact units AX21, AL21

#### General parameters

Contact units for auxiliary and signal contact functions are suitable for all MCCB frame sizes

Auxiliary contacts synchronous with main contacts of the circuit breaker

Signal contacts active on electrical tripping of the circuit breaker (tripping signal contacts)

With connection wires

#### Electrical parameters

	AX21	AL21
Contacts	1 changeover (CO)	1 changeover (CO)
Contact function	auxiliary	signal
Tested according to	IEC/EN 60947-1, IEC/EN 60947-5-1	
Rated op. voltage U	240/415 V AC, 110/220 V DC	
Rated frequency	50/60 Hz	
Rated op. current I <sub>e</sub> AC	5 A (240 V), 2 A (415 V)	
Rated op. current I <sub>e</sub> DC	1 A (110 V), 0.25 A (220 V)	
Rated thermal current I <sub>th</sub>	5 A	
Rated op. current I <sub>e</sub> , ut. cat. AC-15	5 A (240 V), 2 A (415 V)	
Rated op. current I <sub>e</sub> , ut. cat. DC-13	1 A (110 V), 0.25 A (220 V)	
Rated insulation voltage U <sub>i</sub>	500 V	

#### Mechanical parameters

	AX21	AL21
Suitable for	M1, M2, M3, M4, M5	M1, M2, M3, M4, M5
Connection	equipped with connection wires	

#### Wiring diagrams

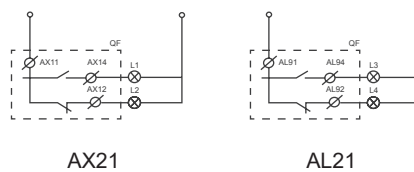

# Technical Data Ex9M Accessories

## Accessories for Moulded Case Circuit Breakers Ex9M

### Early-make auxiliary contacts EC 2i

#### General parameters

Early-make auxiliary contacts

Contact unit EC 21 is installed in the special place in the MCCB (M1, M2 frame size), unit EC 23 as two connected contact units. One in special place and second in AL place (limit use of AL in M3, M4, M5)

Does not limit using of voltage releases and motor operator

Equipped with connection wires

Compatible with MCCB devices produced from 3/2014 only!

Please, note the requirement for early-make contact function in the order of MCCB!

#### Electrical parameters

	EC 21	EC 23
Contacts	1 NO	1 NO
Contact function	early-make auxiliary	
Tested according to	IEC/EN 60947-1, IEC/EN 60947-5-1	
Rated op. voltage U	240/415 V AC, 110/220 V DC	
Rated frequency	50/60 Hz	
Rated op. current I <sub>e</sub> AC	5 A (240 V), 2 A (415 V)	
Rated op. current I <sub>e</sub> DC	1 A (110 V), 0.25 A (220 V)	
Rated thermal current I <sub>th</sub>	5 A	
Rated op. current I <sub>e</sub> , ut. cat. AC-15	5 A (240 V), 2 A (415 V)	
Rated op. current I <sub>e</sub> , ut. cat. DC-13	1 A (110 V), 0.25 A (220 V)	
Rated insulation voltage U <sub>i</sub>	500 V	
Early make function	M1, ON -> OFF: 10 ms M1, OFF -> ON: 15 ms M2, ON -> OFF: 16 ms M2, OFF -> ON: 18 ms	M3, ON -> OFF: 68 ms M3, OFF -> ON: 75 ms M4/M5, ON -> OFF: 82 ms M4/M5, OFF -> ON: 90 ms

#### Mechanical parameters

	EC 21	EC 23
Suitable for	M1, M2	M3, M4, M5
Connection	equipped with connection wires	

# Technical Data Ex9M Accessories

## Accessories for Moulded Case Circuit Breakers Ex9M

### Early-make auxiliary contacts EC 2i

#### Wiring diagrams

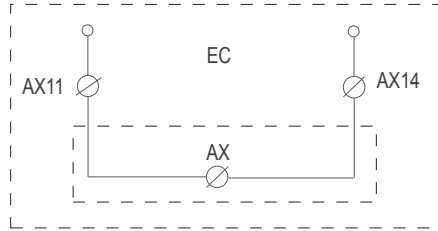

EC 21

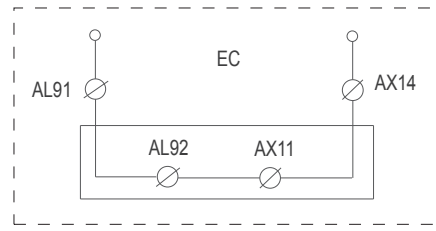

EC 23

#### Mounting position

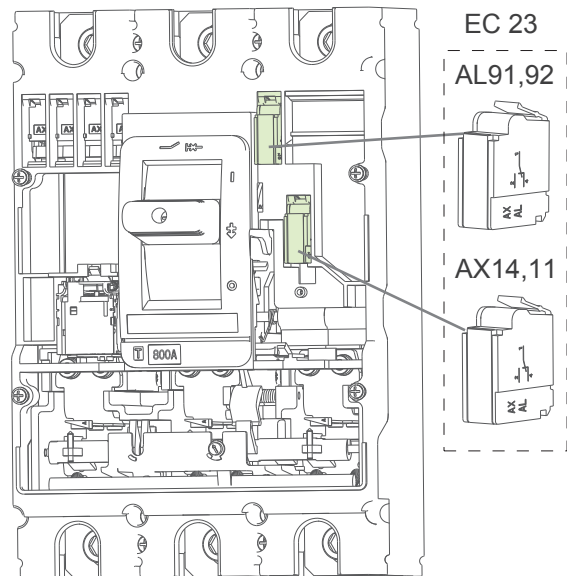
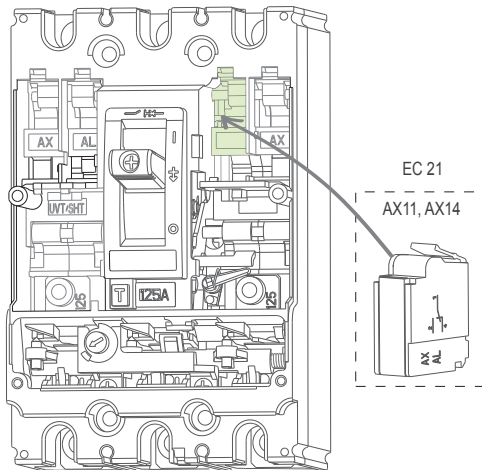

Matching order of the contact units and respective chambers has to be kept!

# Technical Data Ex9M Accessories

## Accessories for Moulded Case Circuit Breakers Ex9M

### Shunt trip releases SHT2*i*

#### General parameters

It is possible to use one unit of shunt trip release SHT2*i* or one unit of undervoltage release UVT2*i*

Can be used for remote switch off

SHT21 for MCCBs of frame size M1

SHT22 for MCCBs of frame sizes M2 and M3

SHT24 for MCCBs of frame sizes M4 and M5

With connection wires

#### Electrical parameters

	SHT21	SHT22	SHT24
Tested according to	IEC/EN 60947-1, IEC/EN 60947-5-1		
Rated operating voltage U (according to type)	48 V AC 110 V AC 220 — 240 V AC 380 — 415 V AC 24 V DC 48 V DC 110 V DC 220 V DC	48 V AC 110 V AC 220 — 240 V AC 380 — 415 V AC 24 V DC 48 V DC 110 V DC 220 V DC	110 V AC 220 — 240 V AC 380 — 415 V AC 110 — 120 V DC 220 V DC 24 V DC 48 V DC
Rated frequency	50/60 Hz DC		
Rated insulation voltage U	500 V		
Tripping time	< 20 ms	< 20 ms	< 30 ms

#### Mechanical parameters

	SHT21	SHT22	SHT24
Suitable for	M1	M2, M3	M4, M5
Connection	equipped with connection wires		

#### Wiring diagrams

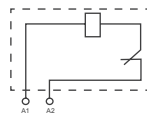

SHT2*i*

# Technical Data Ex9M Accessories

## Accessories for Moulded Case Circuit Breakers Ex9M

### Undervoltage releases UVT2i

#### General parameters

It is possible to use one unit of shunt trip release SHT2i or one unit of undervoltage release UVT2i

To switch connected breaker off in case of voltage drop

UVT21 for MCCBs of frame size M1

UVT22 for MCCBs of frame size M2 and M3

UVT24 for MCCBs of frame size M4 and M5

With connection wires

#### Electrical parameters

	UVT21	UVT22	UVT24
Tested according to	IEC/EN 60947-1, IEC/EN 60947-5-1		
Rated operating voltage $U_n$	220 — 240 V AC 380 — 415 V AC	220 — 240 V AC 380 — 415 V AC	110 V AC 220 — 240 V AC 380 — 415 V AC 110 — 120 V DC 220 V DC 24 V DC 48 V DC
Rated frequency $f$	50/60 Hz DC		
Rated insulation voltage $U_i$	500 V		
Tripping time	< 20 ms	< 20 ms	< 20 ms
Making treshold	85 % $U_n$	85 % $U_n$	85 % $U_n$
Tripping treshold	35 % $U_n$	35 % $U_n$	35 % $U_n$

#### Mechanical parameters

	UVT21	UVT22	UVT24
Suitable for	M1	M2, M3	M4, M5
Connection	equipped with connection wires		

#### Wiring diagrams

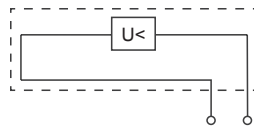

UVT2i

# Technical Data Ex9M Accessories

## Accessories for Moulded Case Circuit Breakers Ex9M

### Direct rotary handles RHD2i

#### General parameters

Rotary handle for direct mounting onto breaker

Scope of delivery: mechanism block, rotary handle

Can be locked in ON and OFF position with up to three padlocks (not in the scope of delivery)

#### Electrical parameters

	RHD21	RHD22	RHD23	RHD24
Tested according to	IEC/EN 60947-3			
Degree of protection	IP40			

#### Mechanical parameters

	RHD21	RHD22	RHD23	RHD24
Suitable for	M1	M2	M3	M4, M5
Mechanical shock resistance	IK07			
Indication	connected breaker status ON-OFF-TRIP			
Mounting	directly onto breaker			
Toggle colour	grey			

#### Dimensions

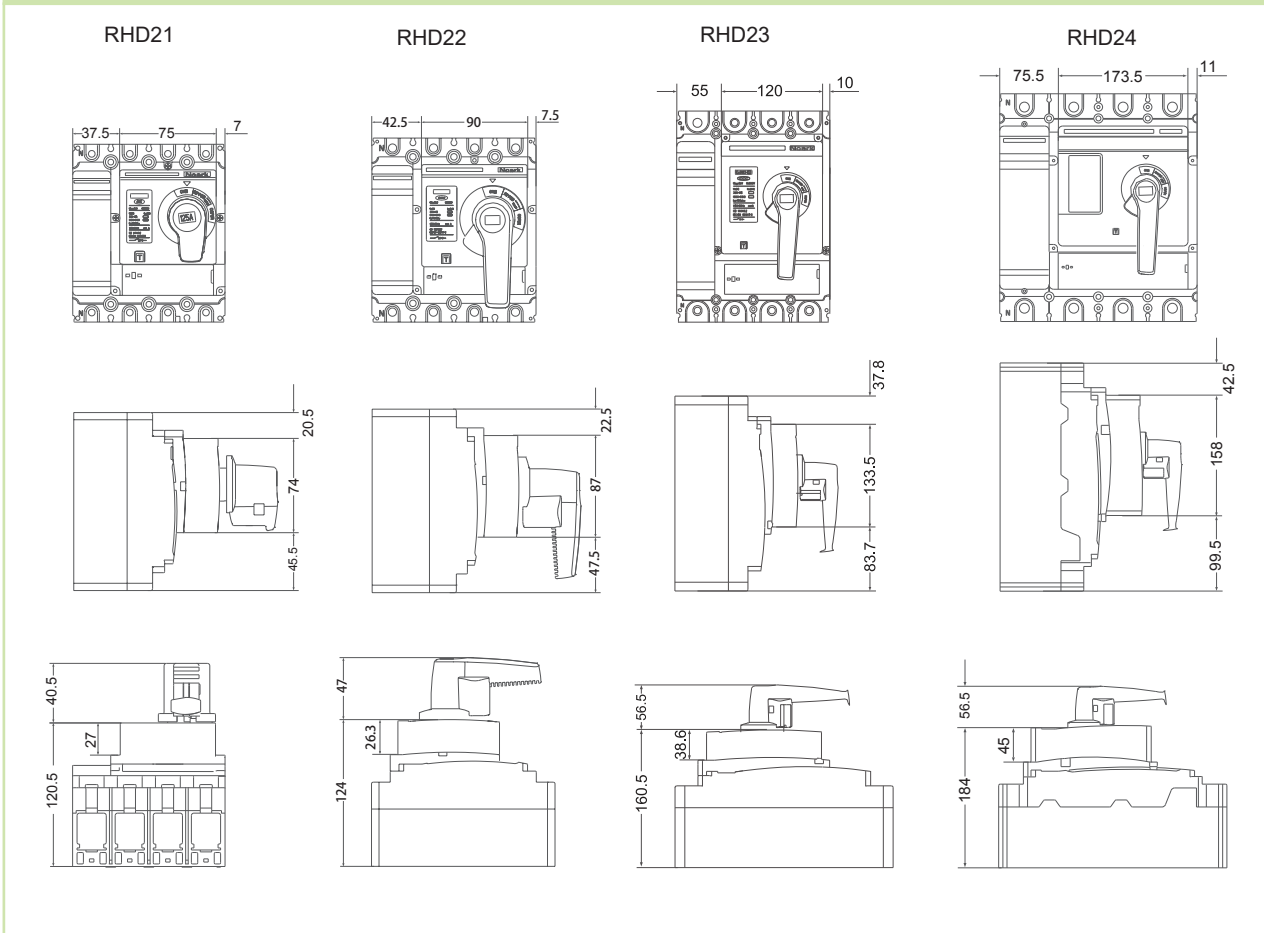

# Technical Data Ex9M Accessories

## Accessories for Moulded Case Circuit Breakers Ex9M

### Extended rotary handles ERH2i

#### General parameters

Rotary handle with extension shaft

Scope of delivery: mechanism block, extension shaft, rotary handle

Can be locked in ON and OFF position with up to three padlocks (not in the scope of delivery)

Extension shaft can be shortened

Possibility of longer extension shaft 500 mm (only the shaft as separated item)

#### Electrical parameters

	ERH21	ERH22	ERH23	ERH24
Tested according to	IEC/EN 60947-3			
Degree of protection	IP54			

#### Mechanical parameters

	ERH21	ERH22	ERH23	ERH24
Suitable for	M1	M2	M3	M4, M5
Length of the extension shaft	300 mm	300 mm	300 mm	300 mm
Mechanical shock resistance	IK08			
Indication	connected breaker status ON-OFF-TRIP			
Mounting	directly onto breaker			
Toggle colour	grey			

#### Dimensions

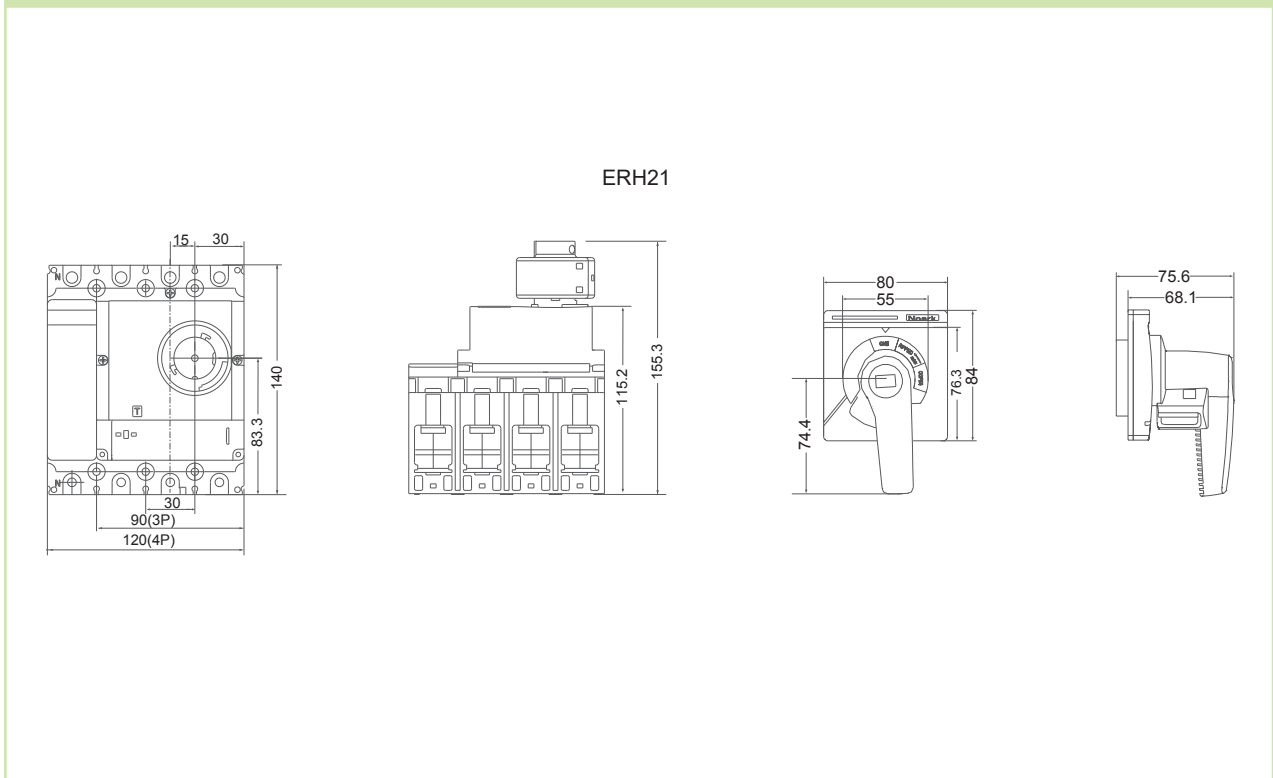

# Technical Data Ex9M Accessories

## Accessories for Moulded Case Circuit Breakers Ex9M

### Extended rotary handles ERH2i

#### Dimensions

ERH22

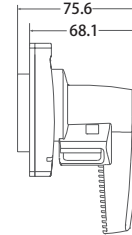
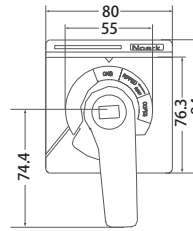
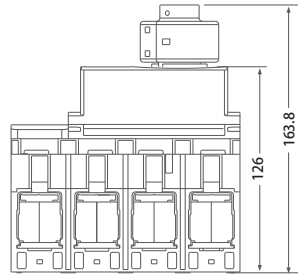
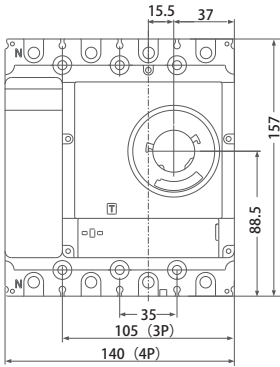

ERH23

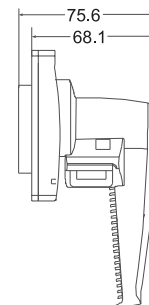
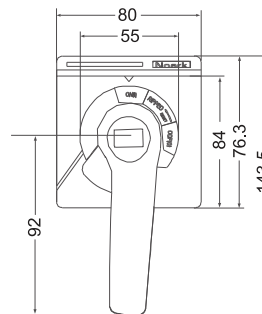
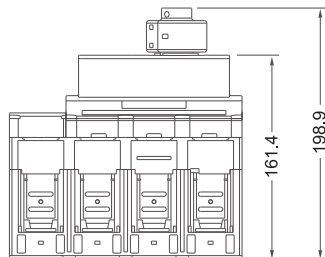
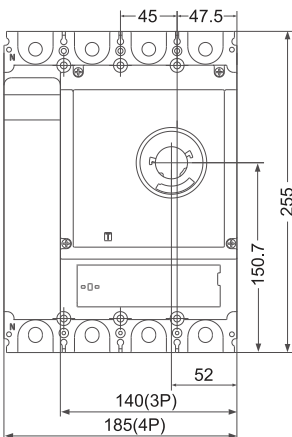

ERH24

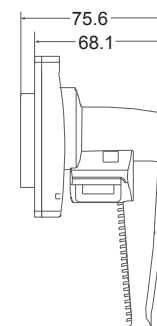
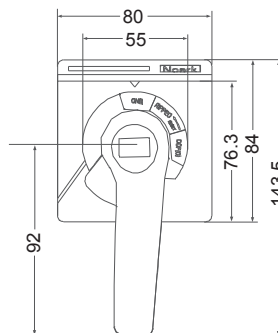
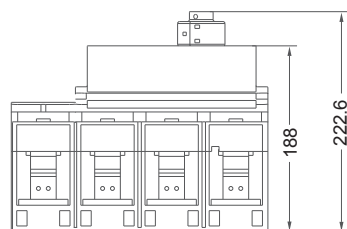
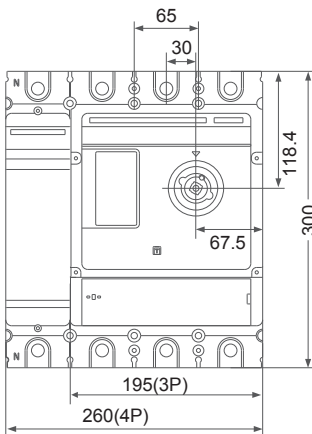

# Technical Data Ex9M Accessories

## Accessories for Moulded Case Circuit Breakers Ex9M

### Remote motor operators MOD2i

#### General parameters

Motor drives for electrical and remote control of MCCBs

#### Electrical parameters

	MOD21	MOD22	MOD23	MOD24
Tested according to	IEC/EN 60947-1, IEC/EN 60947-5-1			
Rated operating voltage $U_s$ (according to type)	230 V AC 110 V AC 220 V DC 110 V DC 24 V DC			
Rated frequency	50/60 Hz DC			
Power consumption	150 VA	150 VA	300 VA	300 VA
Total time to switch ON	75 ms	75 ms	1000 ms	1000 ms
Total time to switch OFF	500 ms	500 ms	1000 ms	1000 ms
Min. pulse duration for ON	300 ms	300 ms	300 ms	300 ms
Min. pulse duration for OFF	300 ms	300 ms	300 ms	300 ms
Max. pulse duration	limited by internal contact switch			

#### Mechanical parameters

	MOD21	MOD22	MOD23	MOD24
Suitable for	M1	M2	M3	M4, M5
Terminals	lift			
Terminal capacity	0.2 — 1.5 mm <sup>2</sup>			
Mechanical service life	10 000 operation cycles		8 000 operation cycles	
Maximum frequency of switch. cycles	120 operating cycles per hour			

#### Wiring diagram

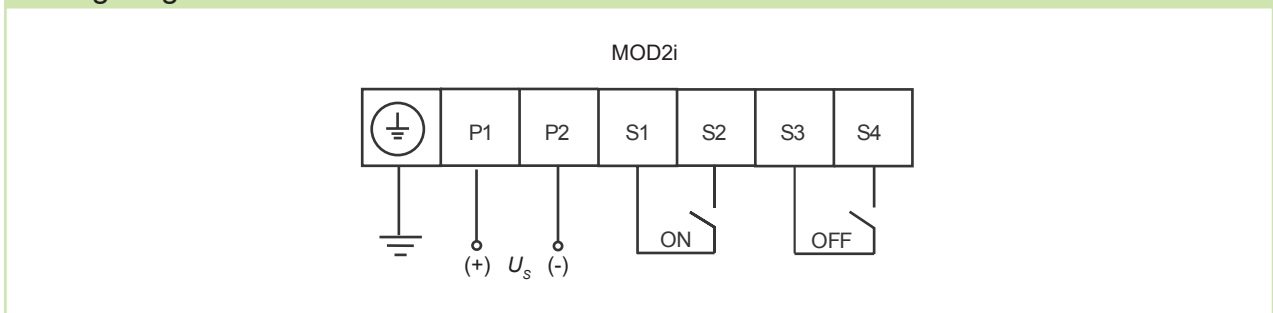

# Technical Data Ex9M Accessories

## Accessories for Moulded Case Circuit Breakers Ex9M

### Remote motor operators MOD2*i*

#### Dimensions

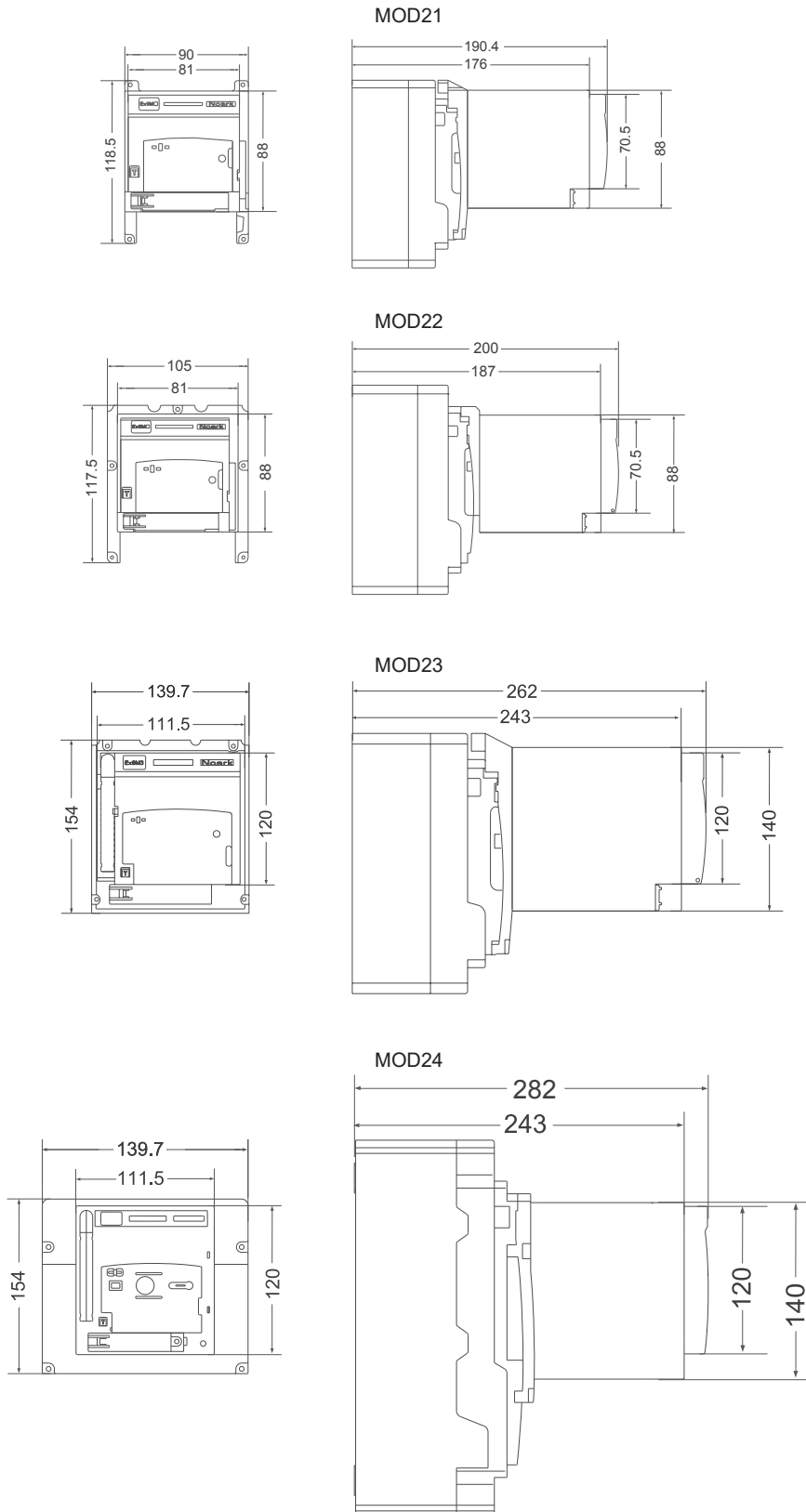

# Technical Data Ex9M Accessories

## Accessories for Moulded Case Circuit Breakers Ex9M

### Connection terminals MC2i

#### General parameters

Box and tunnel connection terminals for Ex9M MCCBs and MCCB based switch disconnectors

Versions suitable for all frame sizes

Screws in the scope of delivery

#### Mechanical parameters - box terminals

	MC21	MC22	MC23	MC23 UL
Suitable for	M1	M2	M3	M3
Terminal type	box			
Terminal capacity	4 — 95 mm <sup>2</sup>	10 — 120 mm <sup>2</sup>	120 — 240 mm <sup>2</sup>	120 — 240 mm <sup>2</sup>
Fastening torque of terminals	8 Nm	25 Nm	35 Nm	35 Nm

#### Drawings - box terminals



MC21(22)



MC23

#### Mechanical parameters - tunnel terminals

	MC21 W	MC22 W	MC22 W2	MC22 W6	MC23 W2	MC23 W4	MC24 W2
Suitable for	M1	M2	M2	M2	M3	M3	M4, M5
Terminal type	tunnel						
Terminal capacity	1x 16 - 95 mm <sup>2</sup>	1x 35 - 240 mm <sup>2</sup>	2x 35 - 120 mm <sup>2</sup>	6x 10 - 35 mm <sup>2</sup>	2x 120 - 240 mm <sup>2</sup>	4x 35 - 95 mm <sup>2</sup>	2x 240 mm <sup>2</sup>
Fastening torque of terminals (to MCCB)	10 - 15 Nm	15 Nm	15 Nm	15 Nm	35 Nm	35 Nm	35 Nm
Fastening torque of terminals (wires)	10 Nm	30 Nm	30 Nm	10 Nm	35 Nm	30 Nm	35 Nm

#### Drawings - tunnel terminals

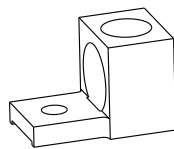

MC21 W

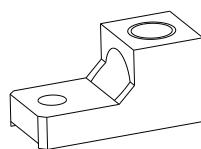

MC22 W

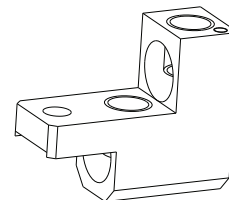

MC22 W2

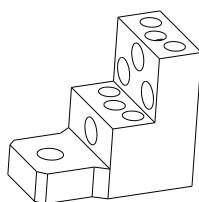

MC22 W6

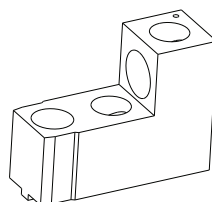

MC23 W2

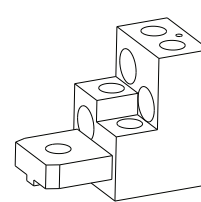

MC23 W4

# Technical Data Ex9M Accessories

## Accessories for Moulded Case Circuit Breakers Ex9M

### DIN-rail adaptors DRA2*i*

#### General parameters

Adaptors for mounting of MCCBs and MCCB Switch Disconnectors onto 35 mm device DIN-rail

Suitable for M1 and M2 frame sizes, 3P and 4P versions

#### Mechanical parameters

	DRA21	DRA22
Suitable for	M1	M2
Mounting	easy mounting onto 35 mm device rail (DIN)	

#### Drawings and dimensions

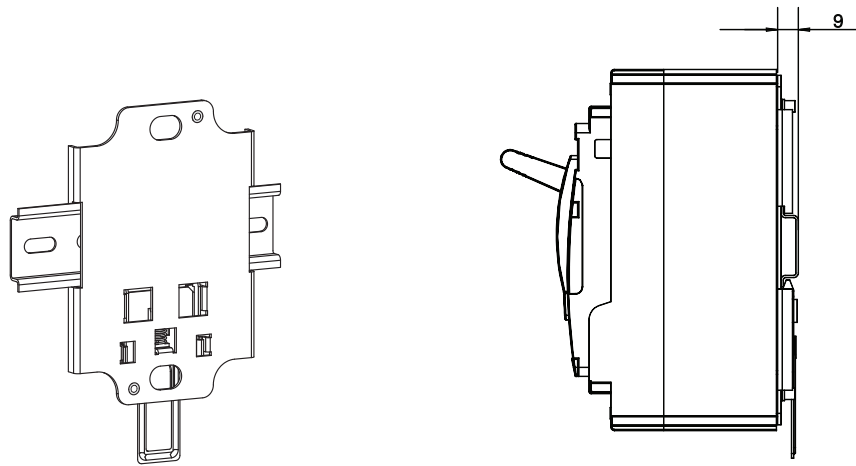

# Technical Data Ex9M Accessories

## Accessories for Moulded Case Circuit Breakers Ex9M

### Mounting depth spacers WG

#### General parameters

Set of mounting depth spacers for compensation of differences in height between frame sizes

Suitable for all variants of MCCBs and MCCB Switch Disconnectors

Variants with height 10 and 13 mm

#### Mechanical parameters

	WG 10	WG 13
Suitable for height compensation	M1 -> M2	M2 -> M3 M3 -> M4/M5
Height	10 mm	13 mm

#### Mounting

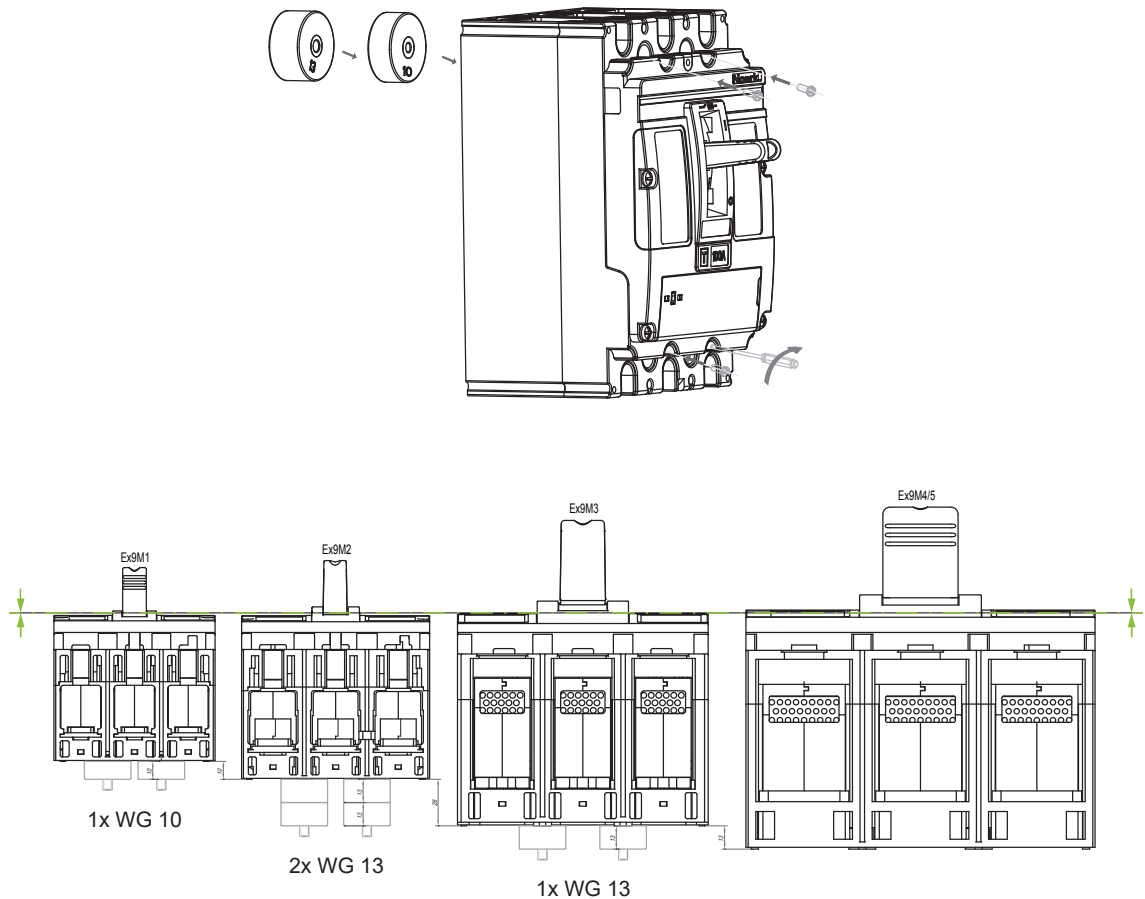

WG \ Ex9M	9M1/9M2	9M1/9M3	9M1/9M4	9M2/9M3	9M2/9M4	9M3/9M4
	WG10	4X	4X	4X		
WG13		8X	12X	8X	12X	4X